

data sheet

COLENTA ONLINE SYSTEM IL ACS 95 S/OL for Creo Scitex DOLEV 4-Press

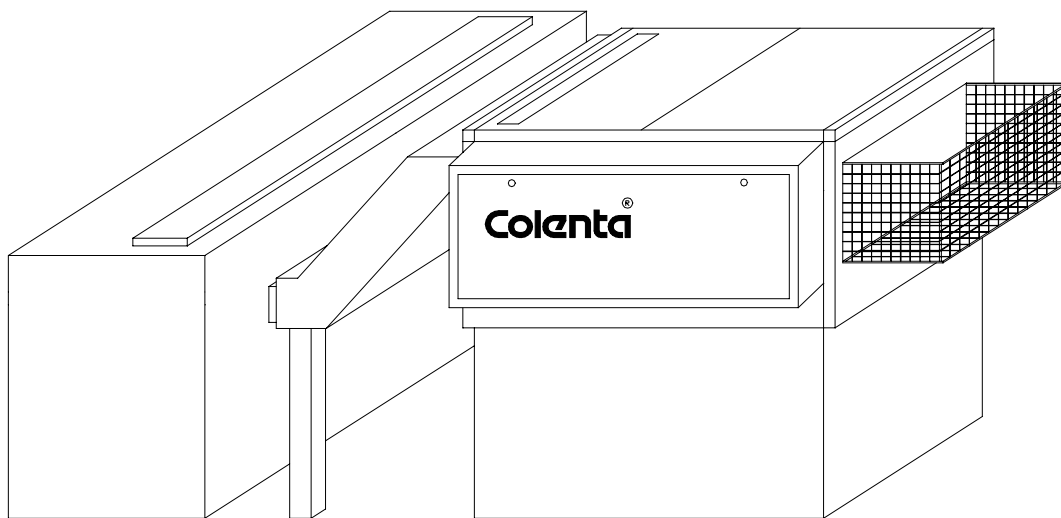

Colenta[®]



for Graphic Art Films or PE-Printing Plates up to 0,2 mm (0,3mm)
IMAGELINE S - TYPE 125 cm/min at 20 sec dev time

Colenta Imageline[®]

IL ACS 95 S/OL

Technical Specifications

All S-model processors have 9 programmable processing channels, an intermediate rinse bath rack system, covered stand, daylight feed box, hose/tube connection (100 mm dia.) facility for ventilation of the processors wet-section to an external exhaust fan and supplied with 2 x 30 lt replenishment storage tanks

With level control in DEV/FIX processor tanks to automatically “top-up” chemistry when levels are low.

With level control in wash tanks: high/low level monitoring with alarm warning.

With automatic wash tank “fill” when processor is switched on.

Film thickness:	min. 0,10 mm up to 0,2mm
PE-Plate thickness:	up to 0,2mm (0,3mm)
Material width:	min. 7,5 cm max. 95cm
Material length:	min. 10 cm
Time in Developer:	min. 20 sec - max. 92 sec
Input speed:	20sec/DEV-Time 125cm/min

IL ACS 95 S/OL

Tank capacity - Developer:	17l
Fixer:	17l
Wash water:	15l

Solution heating(Fix and DEV):	adjustable in a range of 18°C - 43°C (separate inline 350/550W heaters)
Dryer:	warm air variable in a range of 18°C - 55°C
Replenishment:	fully automatic. replenishment is microprocessor controlled and calculated from information received from sensors measuring the width and length of material entering the processor. Replenishment cycles are adjustable.
Wash water distribution:	built in 3-way magnetic valve
Wash water flow rate:	2,5 ltr/min when film is processed
Wash water supply pressure:	3 - 10 bar
Wash water supply:	filtered at a temperature of 8°C - 15°C with 3/4" hose connection
Wash water drain:	32mm (5/4inch) hose or tube

Weight:

	IL ACS 95 S/OL
Empty	330 kg
With solution	379 kg

Technical specification subject to change without notice.

DIMENSIONS:

IL ACS 95 S/OL

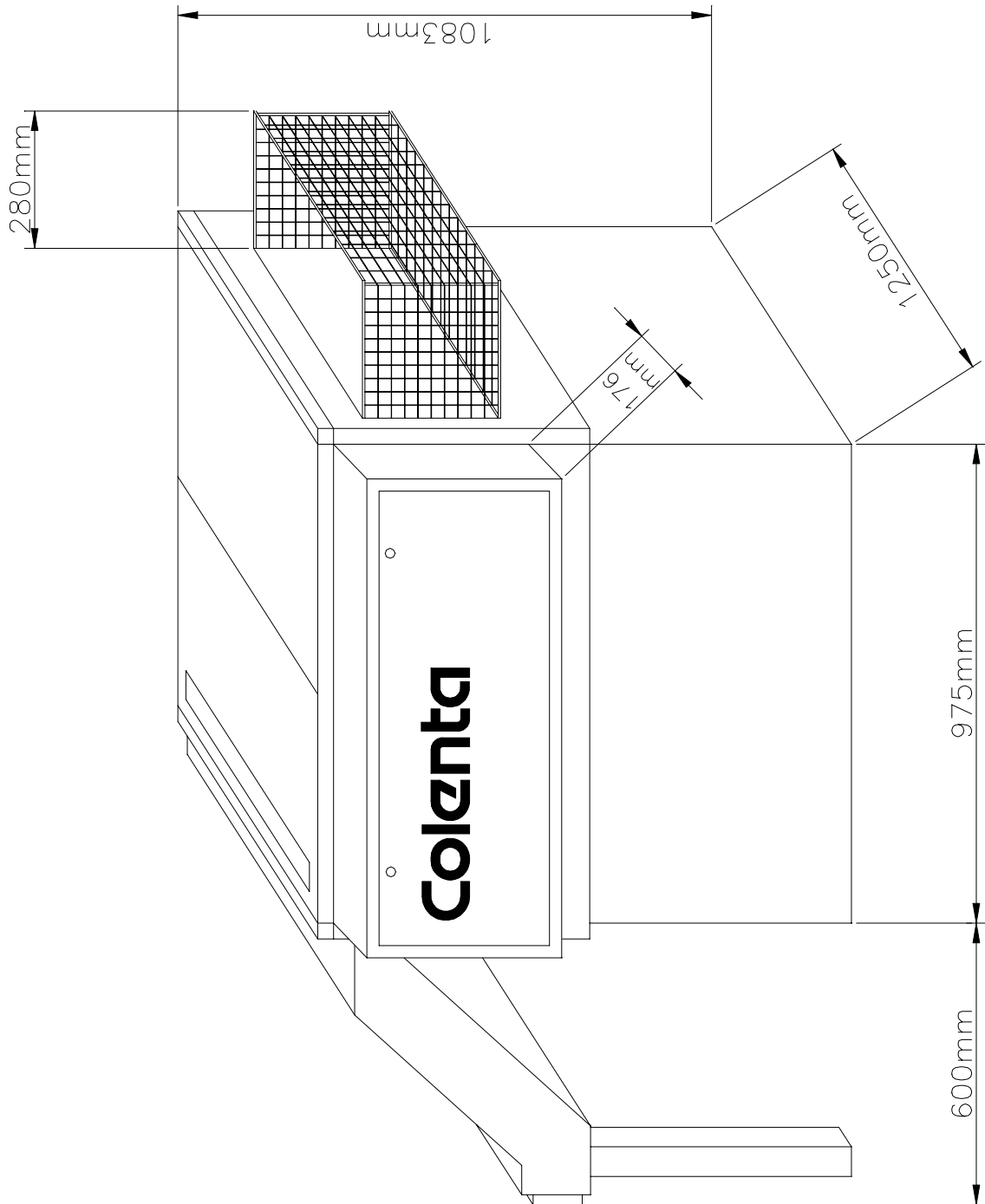

TRANSPORTSYSTEM for:

Colenta

IL ACS 95 S/OL

DRYER

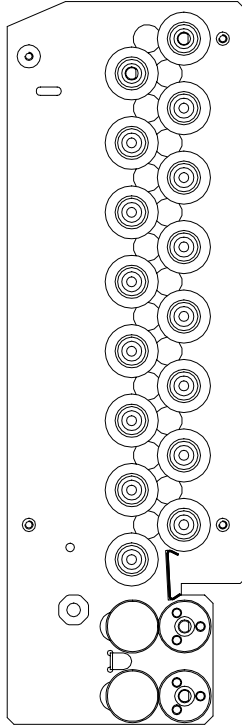

WASH

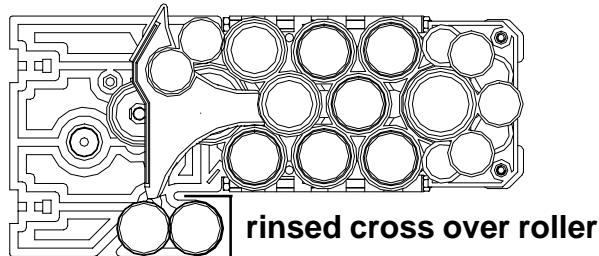

FIX

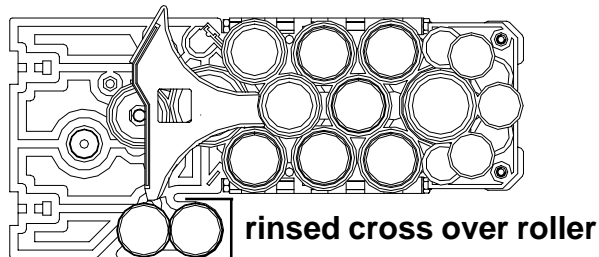

DEV

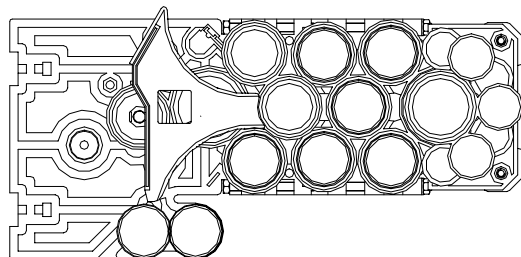

Electrical supply:

Standard, when 3N~400/230V, 50/60 Hz supply available

IL ACS 95 S/OL
3N~ 400/230V 50/60 Hz
6,5 kW
13 A

Colenta

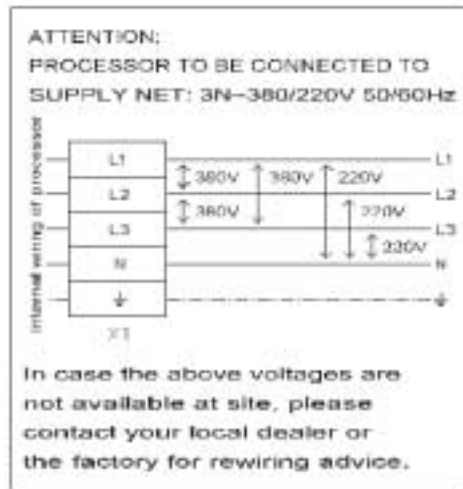

(alternatives, to be indicated when ordering)

IL ACS 95 S/OL
3x220V 50/60 Hz
6,5 kW
20 A

IL ACS 95 S/OL
220V 50/60 Hz Single phase
6,5 kW
32 A

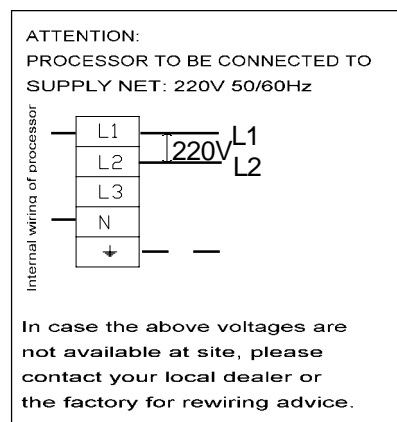
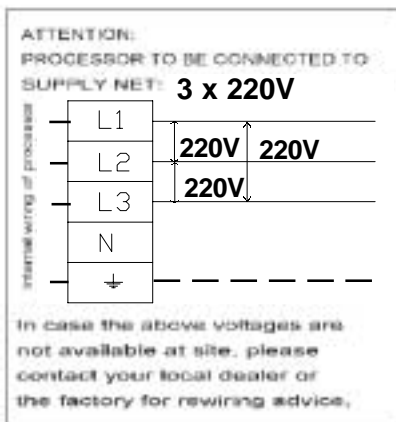

Details for shipment:

IL ACS 95 S/OL

packing dimensions:

2 carton box on palette	volume	weight
180cm x 123cm x 145cm	3,21 m ³	350 kg
125cm x 95cm x 50cm	0,6 m ³	70 kg